

LX Pro Arm Dual Side by Side Desk Mount

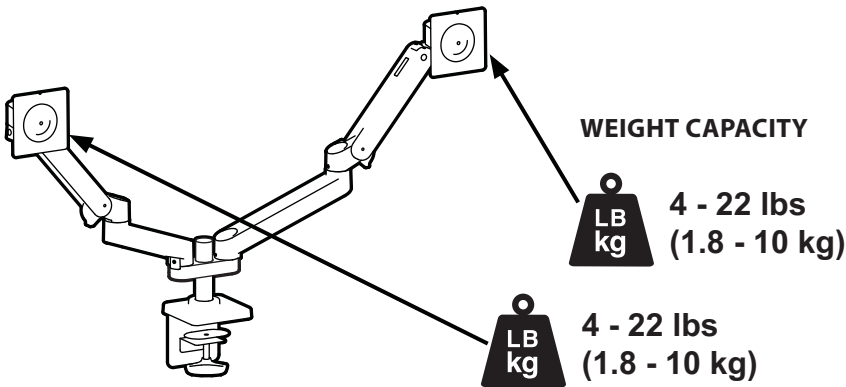

RANGE OF MOTION

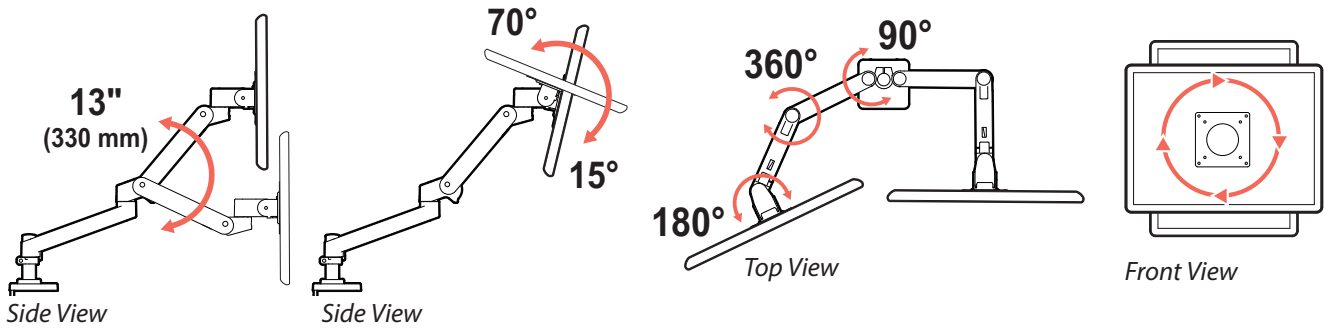

DIMENSIONS

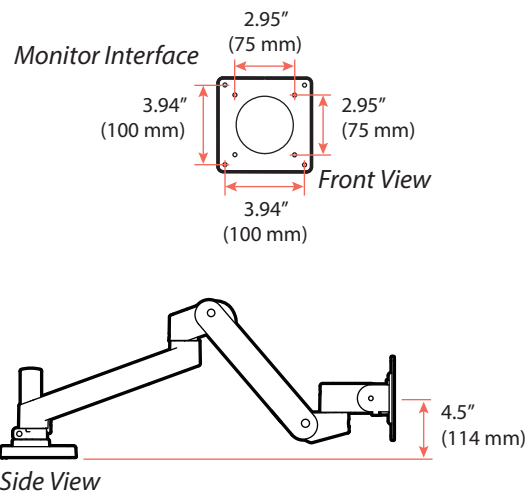
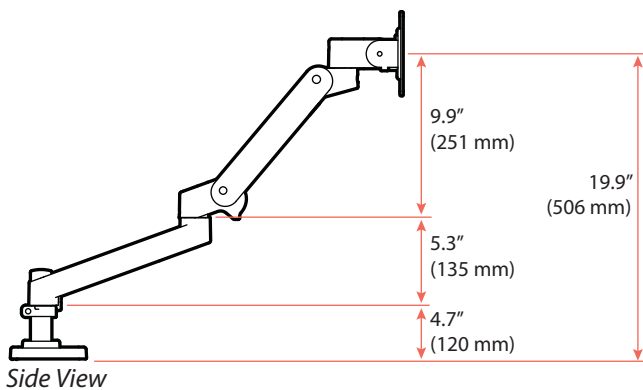

Download additional resources at ergotron.com

USA & Canada Sales & Corporate Headquarters: St. Paul, MN USA / 800.888.8458 / +1.651.681.7600 / insidesales@ergotron.com

EMEA Sales: Amersfoort, The Netherlands / +31.33.45.45.600 / info.eu@ergotron.com

APAC Sales: Sydney, Australia / apaccustomerservice@ergotron.com

LATAM Sales: info.latam@ergotron.com

Worldwide Custom Sales: custom@ergotron.com

Ergotron devices are not intended to cure, treat, mitigate or prevent any disease. Patent information available at www.ergotron.com/patents

© 2024 Ergotron, Inc. rev. 11/06/2024 DIM-LXproSidebySide **Content is subject to change without notification**

LX Pro Arm Dual Side by Side Desk Mount

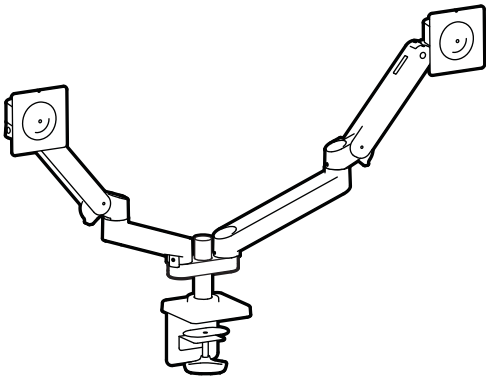

DIMENSIONS

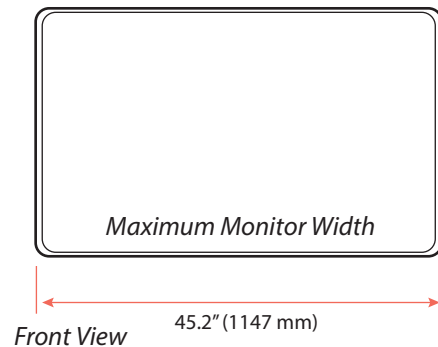
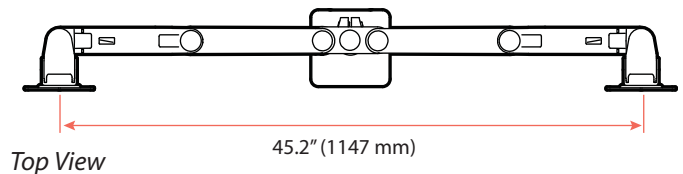
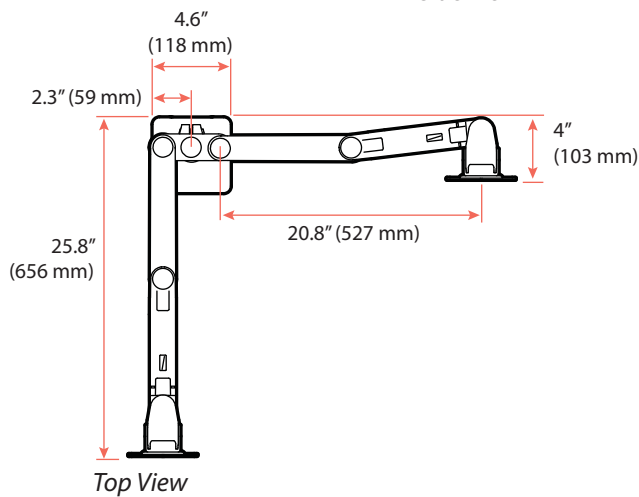
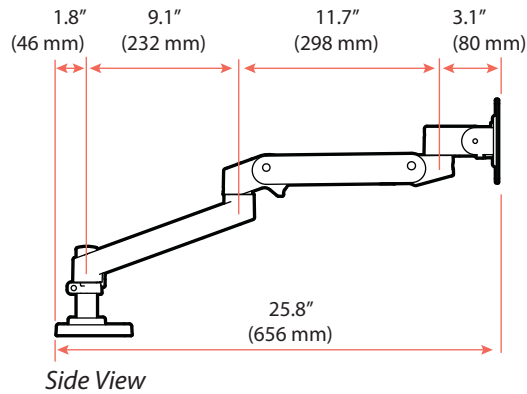

Download additional resources at ergotron.com

USA & Canada Sales & Corporate Headquarters: St. Paul, MN USA / 800.888.8458 / +1.651.681.7600 / insidesales@ergotron.com

EMEA Sales: Amersfoort, The Netherlands / +31.33.45.45.600 / info.eu@ergotron.com

APAC Sales: Sydney, Australia / apaccustomerservice@ergotron.com

LATAM Sales: info.latam@ergotron.com

Worldwide Custom Sales: custom@ergotron.com

Ergotron devices are not intended to cure, treat, mitigate or prevent any disease. Patent information available at www.ergotron.com/patents

© 2024 Ergotron, Inc. rev. 11/06/2024 DIM-LXproSidebySide **Content is subject to change without notification**

LX Pro Arm Dual Side by Side Desk Mount

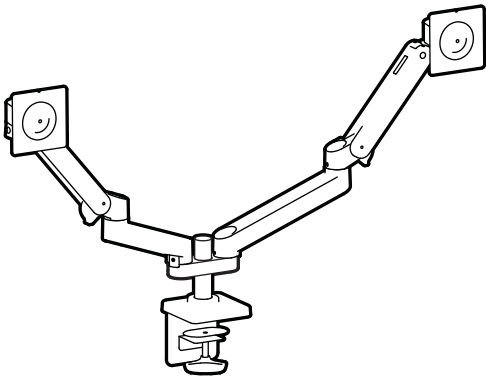

DIMENSIONS

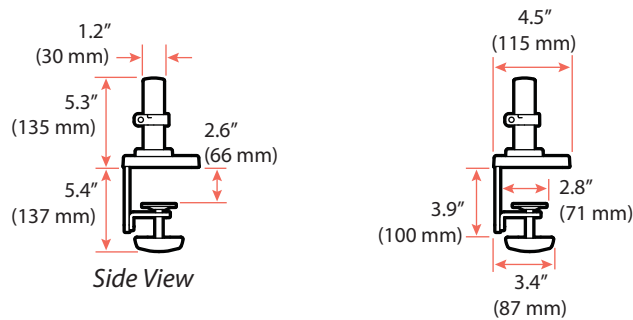

Desk Thickness

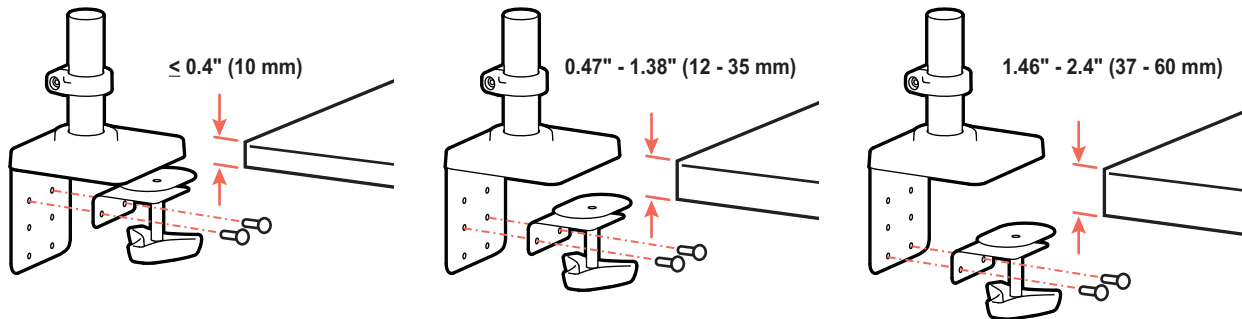

Download additional resources at ergotron.com

USA & Canada Sales & Corporate Headquarters: St. Paul, MN USA / 800.888.8458 / +1.651.681.7600 / insidesales@ergotron.com

EMEA Sales: Amersfoort, The Netherlands / +31.33.45.45.600 / info.eu@ergotron.com

APAC Sales: Sydney, Australia / apaccustomerservice@ergotron.com

LATAM Sales: info.latam@ergotron.com

Worldwide Custom Sales: custom@ergotron.com

Ergotron devices are not intended to cure, treat, mitigate or prevent any disease. Patent information available at www.ergotron.com/patents

© 2024 Ergotron, Inc. rev. 11/06/2024 DIM-LXproSidebySide **Content is subject to change without notification**