



**SITMATIC®**

# LIBRE™



**FREEDOM OF MOTION.**

Uniquely designed to let you move at your workstation!

# LIBRE FEATURES

## Absolute Relaxation

Allowing the elbows to sit slightly behind the shoulder blades to allows a more relaxing posture.

## Intuitive Lumbar Support

Finger tip lever locks where you put it. No other chair adjusts 6".

## The Perfect Height

Seat heights for any size individual. Five different seat heights, ranging between 15" and 34", ensure a perfect fit for everyone at every workstation.



## Unique Backrest Design

The spine well supported, shoulder blades automatically stretch back, and arms are free to move.

## PressureCast™ Cushions

Using a special formulation and cast under high pressure, PressureCast™ foam is incredibly resilient for comfort, yet high-density for longevity.

## Better Mobility

Oversized, 60 mm casters roll easily through plush carpet. Riveted for life-long durability. The aluminum base is cast as a single piece with no welds to break. A convenient foot perch is built-in to each base prong.

## OVERALL DIMENSIONS

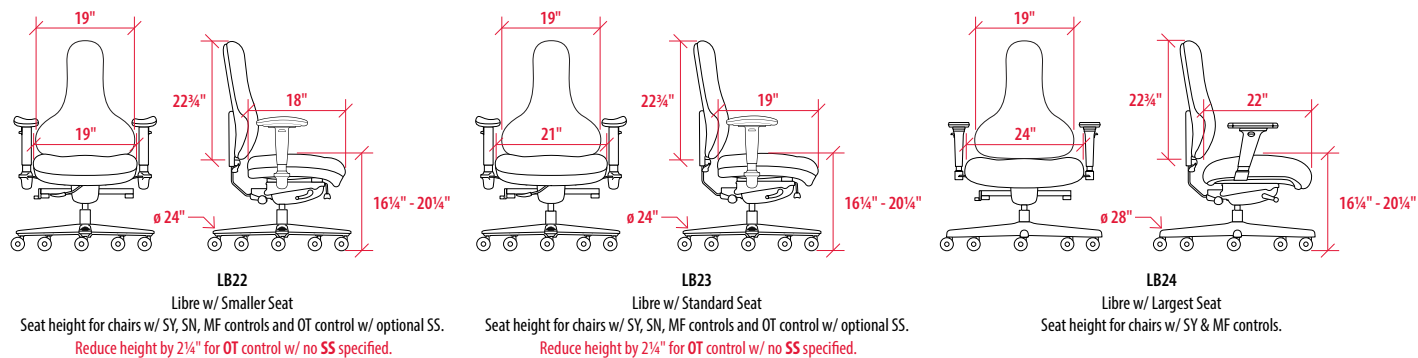

# LIBRE CUSTOM FIT OPTIONS

For more information about custom fit options, please contact customer service at (800) 288-1492.

## BACKREST ADD-ONS

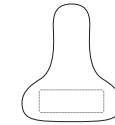

**AL**  
Inflation Air Lumbar

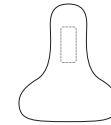

**TH**  
Inflation Thoracic Bolster

## SEAT ADD-ONS

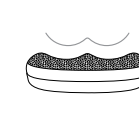

**VS**  
Memory Foam Seat  
1" memory foam seat topper.

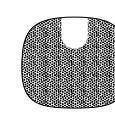

**TS**  
Tailbone Seat Cut-Out  
Coccyx relief; includes (VS) option.

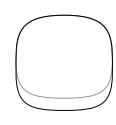

**LS**  
Longer Seat  
2" deeper than standard.

## SEAT HEIGHT OPTIONS



**NC**  
Nano Seat Height  
15 1/4" - 18"  
-2 1/4" for OT mechanism, no SS.

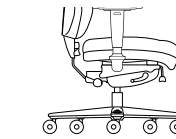

**STANDARD**  
Standard Height  
16 3/4" - 21 1/4"  
-2 1/4" for OT mechanism, no SS.

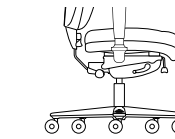

**XC**  
Extended Seat Height  
19 1/2" - 26 1/4"  
-2 1/4" for OT mechanism, no SS.

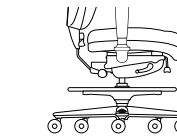

**MK**  
Medium Stool Kit w/ Footring  
22 1/4" - 30"  
-2 1/4" for OT mechanism, no SS.

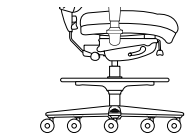

**TK**  
Tall Stool Kit w/ Footring  
24 3/4" - 35"  
-2 1/4" for OT mechanism, no SS.

## ARMREST OPTIONS

If armrests are desired, choose an armrest, then choose an arm cap (Example: 1M).

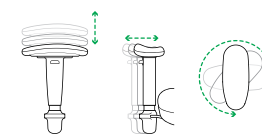

**1-**  
Height, Width & Angle Adjustable Arms  
Shown w/ (A) Contoured Urethane Caps Standard  
Specify **1N** to disable arm rotation.

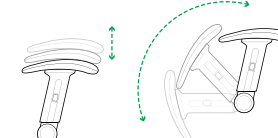

**6-**  
Height Adjustable, Fold-Away Arms  
Shown w/ (K) Kidney-Shaped Urethane Caps Standard  
No width adjustment.

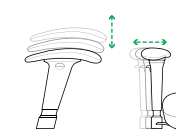

**7-**  
Height & Width Adjustable, Forward Slanting Arms  
Shown w/ (K) Kidney-Shaped Urethane Caps Standard

## ARM CAP OPTIONS

If armrests are desired, choose an armrest, then choose an arm cap (Example: 1M).



**A**  
Contoured Urethane Caps  
Standard on 1A & 1N arms.



**K**  
Kidney-Shaped Urethane Caps  
Standard on 7K and 6K arms.



**M**  
Memory Foam Caps  
Extra Wide, Tapered  
Not compatible w/ fold-away arms.

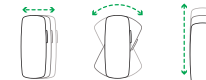

**L**  
Lockable, Urethane Caps  
Width, Angle & Depth Adjustable

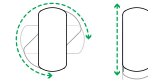

**U**  
Depth & Pivoting Memory Foam Caps



# SITMATIC®

## Exceptional Range of Seating Solutions



### Management, Executive and Conference Seating

---



### Highly Ergonomic Seating

---



### Occasional and Stacking Chairs

---



### Auditorium and Public Area Seating

---

For further information on our comprehensive range of seating please visit our website or call our toll free number. Specifications are subject to change without notice.

#### Sitmatic

1800 Raymer Avenue  
Fullerton, California 92833

Tel: 800.288.1492  
714.888.2500

Fax: 714.888.2505

E-Mail: [Info@Sitmatic.com](mailto:Info@Sitmatic.com)

Website: [www.sitmatic.com](http://www.sitmatic.com)



Sitmatic seating is covered by our comprehensive lifetime structural warranty. Specifications are subject to change without notice.



Sitmatic seating has passed the stringent testing procedures established by ANSI/BIFMA and CAL 117.



Sitmatic literature is printed on certified recycled paper and paper from well-managed forests and controlled sources.



**Green Check Certified**

Our products are certified compliant for LEED-CI indoor environmental air quality. Choosing Sitmatic chairs for your work place contributes to a cleaner, safer, more sustainable environment.